

**barkman™**

Barkman Landscape Kits

# Quarry Stone Fireplace

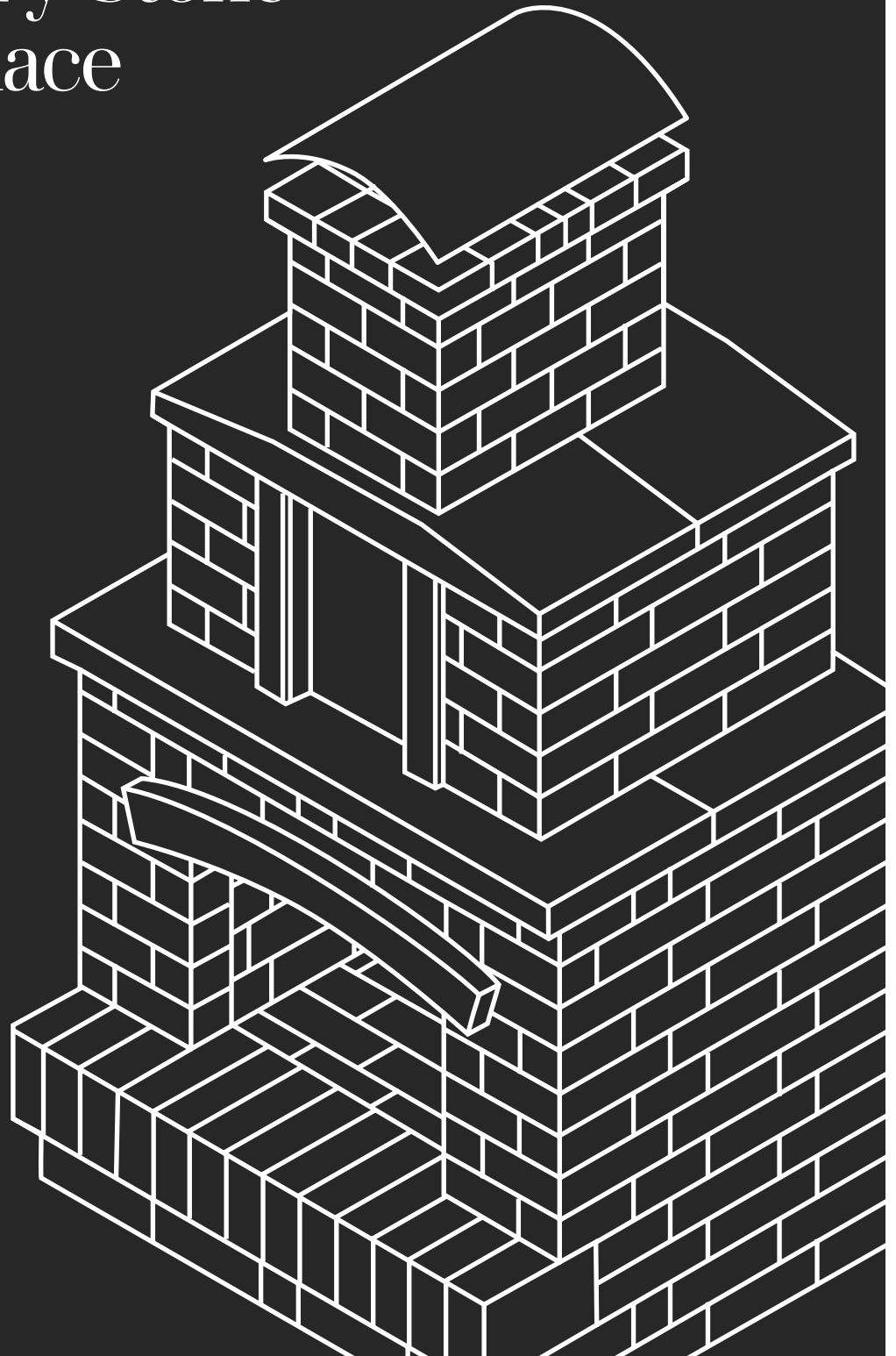

# IMPORTANT: READ PRIOR TO INSTALLATION

It is the responsibility of the consumer to read and follow the proceeding information.

## **WARNING**

1. Failure to follow these instructions could result in fire or explosion, which could cause property damage, personal injury or death.
2. Improper installation or maintenance of this product may result in damage to property, injury or death.
3. Read the installation, operation and maintenance instructions thoroughly before installing or servicing this equipment.
4. Barkman Concrete Ltd. is not liable for any property damage or bodily injury caused by failure to follow the installation instructions, improper use of the product or any negligence or carelessness of the consumer.

## **INSTALLATION AND USE**

1. Improper installation, adjustment, alteration, service or maintenance can cause injury, or property damage. Read the installation instructions thoroughly before installing the fireplace.
2. DO NOT touch areas if fire is burning, severe burning may result. Clothing ignition may result.
3. Carefully supervise children near the fireplace.
4. Keep clothing, furniture, draperies and other combustibles away from the fireplace.
5. Fireplace is for outdoor use only. Place the fireplace in an area where wind won't disturb the flames.
6. DO NOT obstruct the opening of the fireplace, or otherwise obstruct the flow of air.
7. Firebox-related fire can occur when there is a failure to maintain the required clearances (air spaces) to combustible materials.
8. Certain steps in the installation process will require more than one person.
9. Curing is crucial to the operation of your fireplace. Ensure to follow the direction on page 14 of the instruction guide.
10. Plan to install the fireplace a week before intended use to allow enough time for the curing process.
11. Never leave the fireplace unattended when in use.
12. We strongly recommend the installation of a steel fireplace grate on the floor of the fireplace before starting to make fires. This makes it easier to ignite the fire, directing heat away from the floor which extends the life of the floor by inhibiting the formation of small cracks from excess heat. These grates are available at hardware and building supply outlets.

## **DANGERS OF FIRE**

1. If the information in these instructions is not followed exactly, a fire or explosion may result in property damage, injury or death.
2. Beware of flying sparks from mouth of the firebox. Make sure that no combustible materials are within range of fireplace at any time.
3. Beware of extremely high temperatures in the fireplace when in use and for hours after use. Do not put unprotected hands or arms inside while the fireplace is lit.

4. DO NOT use charcoal, pressure treated lumber, chipped wood products, sappy wood (such as pine), laminated wood, or any material other than dry medium or hard natural firewood.
5. DO NOT use liquid fuel (firelighter fluid, gasoline, kerosene or similar liquids) to start or maintain a fire.

## PROXIMITY TO BUILDINGS AND OTHER COMBUSTIBLE MATERIALS

1. The fireplace should be installed and used in accordance with the by-laws, regulations, local building codes and laws of your jurisdiction. Please confirm that use of this product is in compliance with the by-laws, regulations and laws of your jurisdiction before installing or using it.
2. Make sure that you locate your respective gas lines, wires, water pipes, and/or any above ground and underground services in your area and install your fireplace in the proper distance away from them. Check with your provider for location and distance requirements prior to installation.
3. This manual must be kept by the customer as long as they own their fireplace kit.
4. Check with your insurance provider concerning the installation, use, value implications and/or any other considerations in regards to your fireplace kit.



### FIRE WARNING

Do not use landscape glue to seal fire bricks. Only use **SILICONE** to fill in gaps between the Quarry Stones and apply from the interior fireplace. Do not overload wood in the fireplace when in use.

# Materials

This kit measures 52"W x 40"D x 97.375"H.

## MATERIALS INCLUDED:

- 12 x 4 in Quarry Stone – 2 pieces
- 12 x 3.5 in Quarry Stone – 1 pieces
- 8 x 12 in Quarry Stone – 149 pieces
- 8 x 12 in Accent Stone – 13 pieces
- 8 x 8 in Quarry Stone – 21 pieces
- 4.5 x 8 in Quarry Stone – 2 pieces
- 4 x 8 in Quarry Stone – 84 pieces
- 4 x 5.5 in Quarry Stone – 2 pieces
- 4 x 4 in Quarry Stone – 23 pieces
- 2.5 x 9 x 4.5 Fire Brick – 70 pieces
- 2.5 x 1.5 x 9 Fire Brick – 4 pieces
- 2.5 x 6 x 4.5 Fire Brick – 8 pieces
- 2.5 x 4.5 x 4.5 Fire Brick – 4 pieces
- 2.5 x 4 x 4.5 Fire Brick – 4 pieces
- 2.5 x 3.5 x 4.5 Fire Brick – 6 pieces
- Front (small) and Back (large) Mantle
- Arch
- Fireplace Cap
- Recess Panel
- Front and Back Roof
- Spark Arrestor
- Rain Cap
- 3 Tubes of Landscape Glue
- 4 Tubes of High Temperature Silicone
- Gloves
- Plastic and Steel Shims
- Fireplace Manual

## OTHER ITEMS NEEDED:

- Caulking gun
- Measuring tape/ruler
- Level
- Rubber Mallet

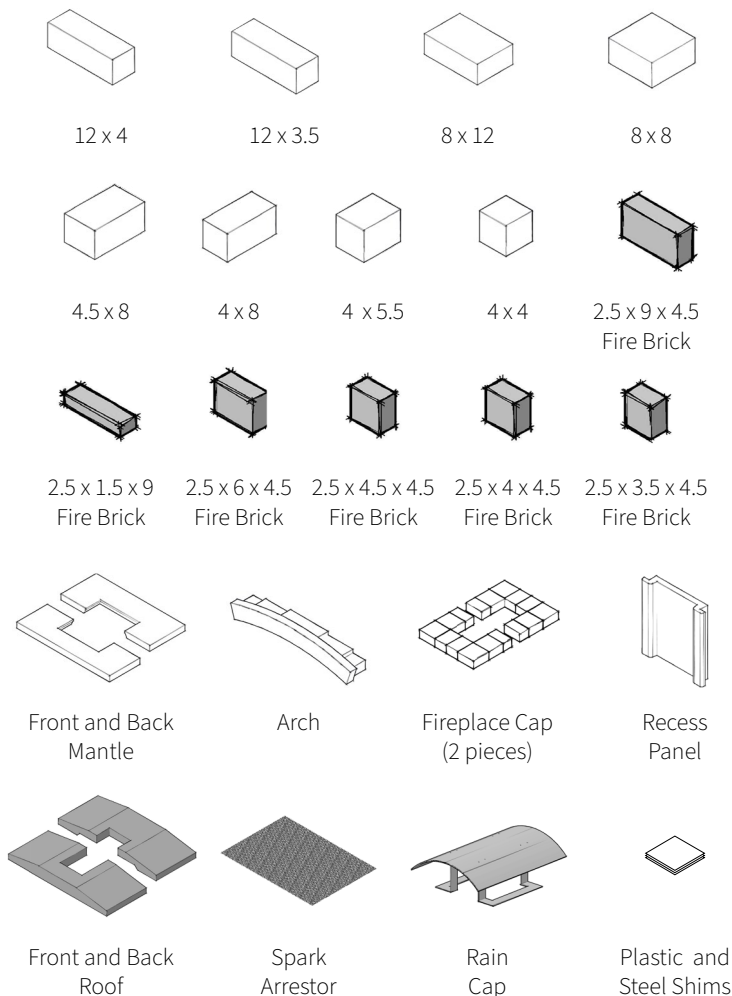

# Base Preparation

## If installing your Quarry Stone Fireplace on an unstructured base, please ensure to follow these steps:

- Excavate area approx. 9 inches below grade.
- Excavate approx. 6 inches larger than your actual kit dimensions to ensure a stable base.
- Fill with 0.75 inch down limestone and compact firmly.
- Level out 0.5 inch of sand and install kit as per the instruction guide.

## If you are installing on a solid base such as an existing patio, base prep is not necessary. Please proceed to the first step.

These instructions may not refer to all base conditions. As this kit is incredibly heavy, base prep will greatly depend on existing ground conditions and may require alternate techniques.

**Note:** This manual was updated in April, 2021. Check [www.barkmanconcrete.com/resources](http://www.barkmanconcrete.com/resources) for any manual updates.

# Instructions

---

## 1

**A** On your prepared level base, lay out the first layer of the fireplace base as indicated in the diagram.

**USE:**

- (21) 8 x 12 blocks
- (2) 4 x 8 blocks

**IMPORTANT:** Periodic checks must be made to ensure that the layers remain level. If layers are not level, use the included shims to adjust as necessary.

---

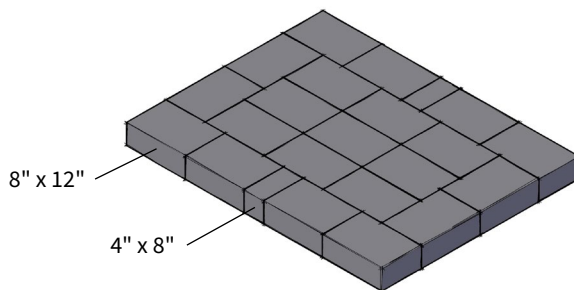

## 2

**A** Lay out the second layer as shown in the diagram.

**USE:**

- (20) 8 x 12 blocks
- (5) 4 x 8 blocks

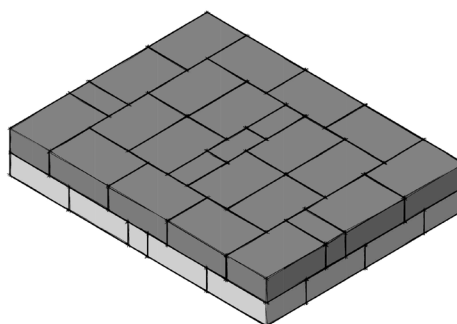

## 3

**A** Lay out the third layer as shown in the diagram.

**USE:**

- (17) 8 x 12 blocks
- (1) 4 x 8 blocks

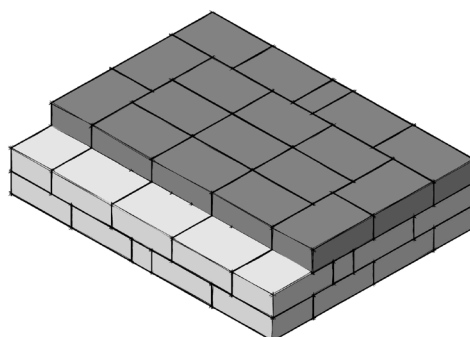

# 4

**A** Lay out the accent band as shown in the diagram.

**B** Glue the accent band in place where it contacts the Quarry Stone behind and below using the included landscape glue.

**USE:**

(13) 8 x 12 Accent Stone

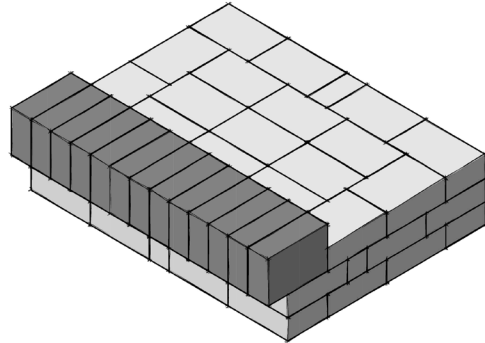

# 5

**A** Lay out the fourth layer of the wood box surround as shown in the diagram

**USE:**

(7) 8 x 12 blocks  
(2) 8 x 8 blocks

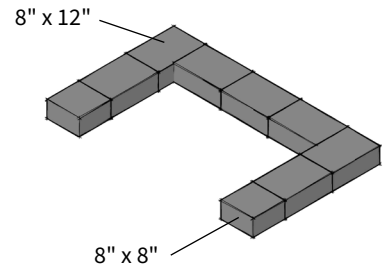
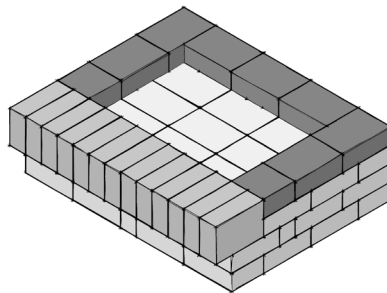

# 6

**A** Lay out the Fire Bricks as indicated in the diagram.

**B** Using a mallet, ensure the outer quarry stone fits tightly around the fire brick.

**USE:**

(18) 2.5 x 9 x 4.5 Fire Bricks  
(4) 2.5 x 4.5 x 4.5 Fire Bricks  
(4) 2.5 x 1.5 x 9 Fire Bricks

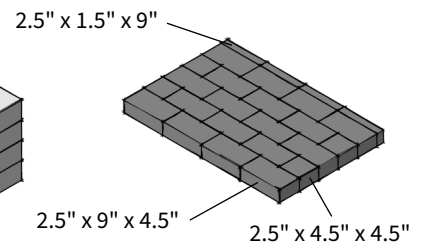
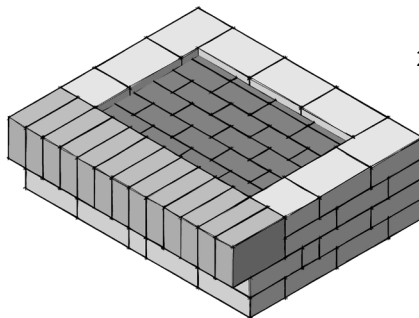

**NOTE:** Do not put silicone on any of the fire brick. They should only be dry stacked, allowing for any bricks to be replaced if necessary. Fill any gaps between the Quarry Stone with silicone. Fill these gaps from the interior of the fireplace so no silicone is shown from the outside.

# 7

- A** Lay out the first layer of the wall surround as indicated in the diagram.
- B** Glue this layer down using the included landscape glue.

**USE:**

- (6) 8 x 12 blocks
- (2) 8 x 8 blocks
- (5) 4 x 8 blocks
- (2) 4 x 4 blocks

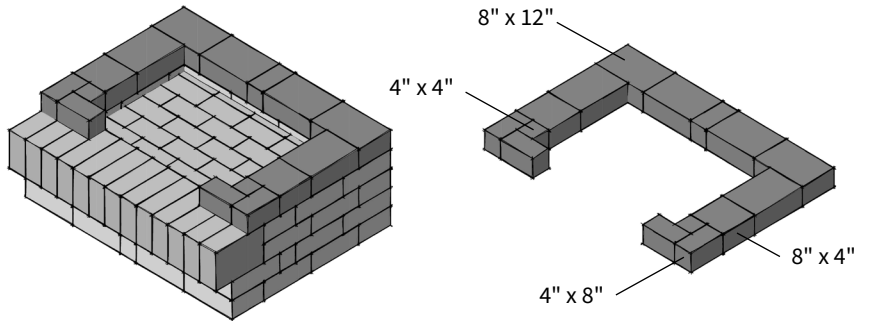

# 8

- A** Place the first row of Fire Brick as indicated.
- B** Using a rubber mallet, tap the Quarry Stone to tightly fit against Fire Brick.

**USE:**

- (7) 2.5 x 9 x 4.5 Fire Bricks
- (2) 2.5 x 6 x 4.5 Fire Bricks
- (1) 2.5 x 4 x 4.5 Fire Bricks

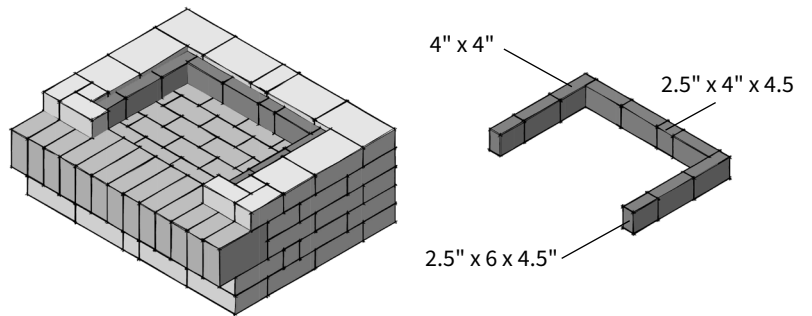

**⚠ WARNING:** Only use **silicone** when securing the fire brick. **Do not** use glue. Fire bricks are very light and heat resistant but must be handled with care to avoid chipping upon installation.

# 9

- A** Lay out the second layer of the wall surround as indicated in the diagram.
- B** Glue the 4 x 4 Quarry Stone down using the included landscape glue.

**USE:**

- (9) 8 x 12 blocks
- (2) 4 x 4 blocks

**IMPORTANT:** Periodic checks must be made to ensure that the layers remain level. If layers are not level, use the included shims to adjust as necessary.

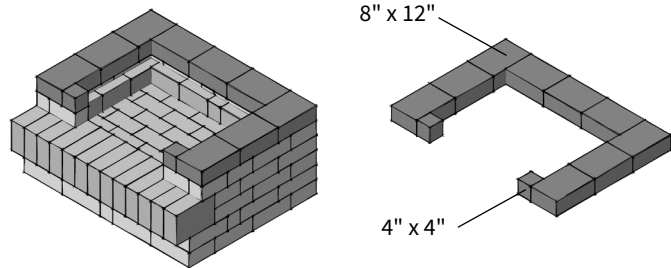

**Applying Glue and Silicone:** Add 2 small dots of landscape glue to the centre of each Quarry Stone block. Press each block into place so that there is no gap between blocks. If a shim is used on a block, apply a line of landscape glue across the entire block.

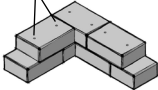

Dots of landscape glue

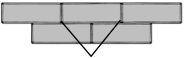

Apply silicone in the Quarry Stone gaps from the fireplace interior to fill spaces in between so no light passes through.

# 10

- A** Place the second row of Fire Brick as indicated.
- B** Using a rubber mallet, tap the Quarry Stone to tightly fit against Fire Brick.

**USE:**

- (8) 2.5 x 9 x 4.5 Fire Bricks
- (2) 2.5 x 3.5 x 4.5 Fire Bricks

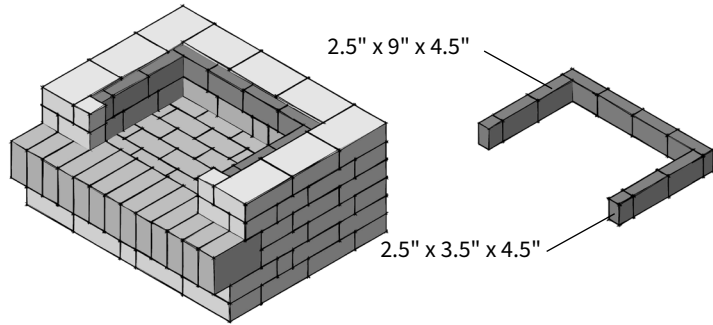

# 11

- A** Repeat patterns from steps 7-10 to a height of 5 layers.

**USE:**

- (36) 8 x 12 blocks
- (6) 8 x 8 blocks
- (15) 4 x 8 blocks
- (6) 4 x 4 blocks
- (37) 2.5 x 9 x 4.5 Fire Bricks
- (8) 2.5 x 6 x 4.5 Fire Bricks
- (3) 2.5 x 4 x 4.5 Fire Bricks
- (4) 2.5 x 3.5 x 4.5 Fire Bricks

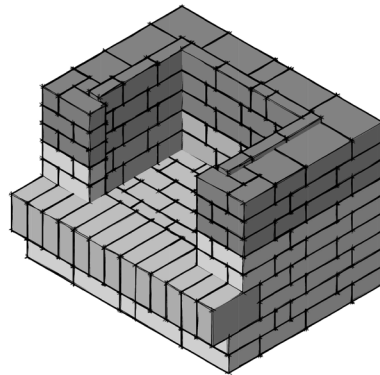

# 12

- A** Lay out the sixth layer of the wall surround as indicated in the diagram.

**USE:**

- (9) 8 x 12 blocks

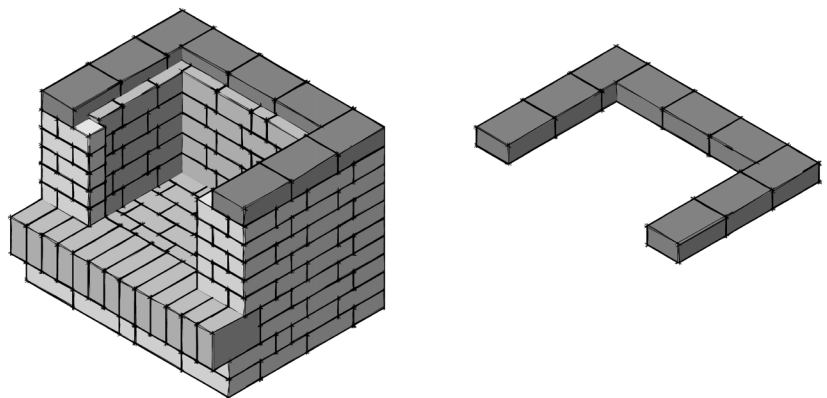



# 13

- A** Place the Arch into the seventh layer as indicated in the diagram.
- B** Glue the Arch down where it contacts the Quarry Stone below using the included landscape glue.

**USE:**  
(1) Arch

**IMPORTANT:** Be sure to hold the arch in place until the next layer of quarry stone is set atop of it. Only use steel shims above the arch.

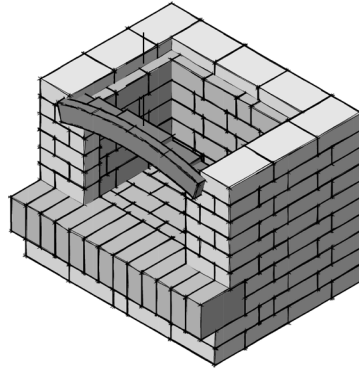

# 14

- A** Lay out the seventh layer of the wall surround as indicated in the diagram.

**USE:**  
(1) 12 x 3.5 blocks  
(8) 8 x 12 blocks  
(2) 4.5 x 8 blocks  
(3) 4 x 8 blocks  
(2) 4 x 5.5 blocks

**IMPORTANT:** Fill in any large gaps between the Quarry Stone above the Arch with steel shims and high temperature silicone from the interior of the fireplace.

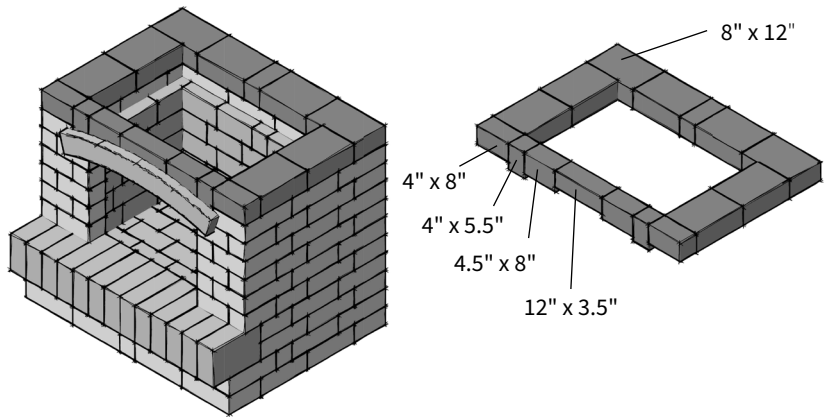

# 15

- A** Place the sixth row of Fire Brick as indicated in the image.
- B** Using a rubber mallet, tap the Quarry Stones to tightly fit against Fire Brick.

**USE:**  
(8) 2.5 x 9 x 4.5 Fire Bricks  
(2) 2.5 x 3.5 x 4.5 Fire Bricks

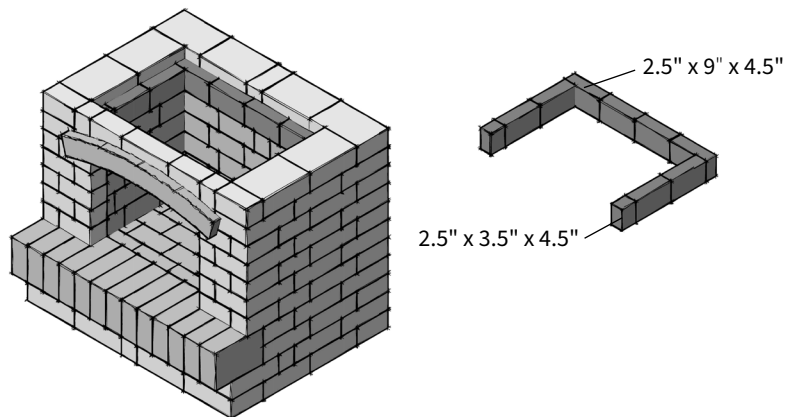

# 16

- A** Lay out the eighth layer of the wall surround as indicated in the diagram.
- B** Glue this layer down using the included landscape glue.

**USE:**

- (7) 8 x 12 blocks
- (6) 4 x 8 blocks
- (3) 4 x 4 blocks
- (2) 12 x 4 blocks

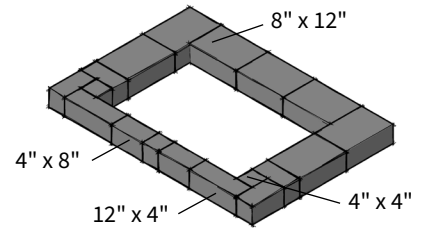
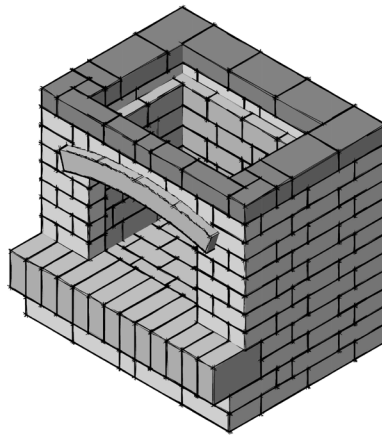

# 17

- A** Place the seventh row of Fire Brick as indicated.
- B** Using a rubber mallet, tap the Quarry Stones to tightly fit against Fire Brick.

**USE:**

- (7) 2.5 x 9 x 4.5 Fire Bricks
- (2) 2.5 x 6 x 4.5 Fire Bricks
- (1) 2.5 x 4 x 4.5 Fire Bricks

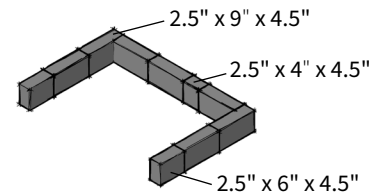
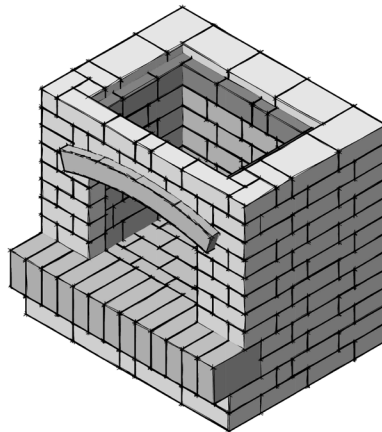

# 18

- A** Install the mantle pieces as indicated in the diagram.
- B** Adjust the mantle as needed to ensure that it is centered with a 2" overhang at the front.

**USE:**

Mantle (Front and Back)

**IMPORTANT:** Fill in any gaps between the Quarry Stone and mantel pieces with high temperature silicone from the interior of the fireplace, allowing no light to pass between the blocks.

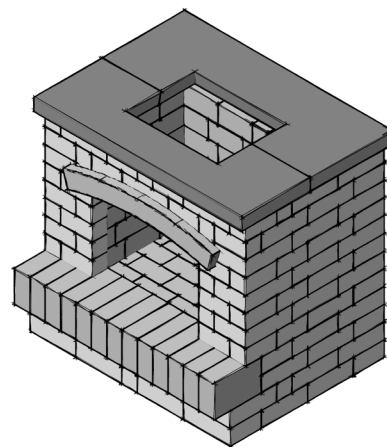

# 19

- A** Centre the recess panel on the mantle and lay out the first layer of the wall surround. Quarry stone sits in recess panel notch in all 5 layers.
- B** Glue this layer down using the included landscape glue, except for the recess panel in case you want an access point to the chimney.

**USE:**

- (4) 8 x 12 blocks
- (3) 8 x 8 blocks
- (4) 4 x 8 blocks
- (2) 4 x 4 blocks

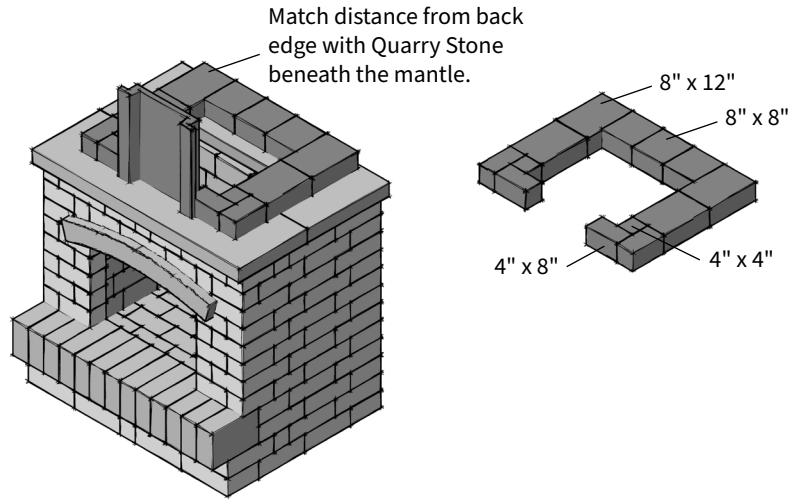

# 20

- A** Lay out the second layer of the wall surround as shown in the diagram.

**USE:**

- (6) 8 x 12 blocks
- (2) 8 x 8 blocks
- (2) 4 x 4 blocks

**IMPORTANT:** Periodic checks must be made to ensure that the layers remain level. If layers are not level, use the included shims to adjust as necessary. Fill any large gaps between the Quarry Stone with the included silicone.

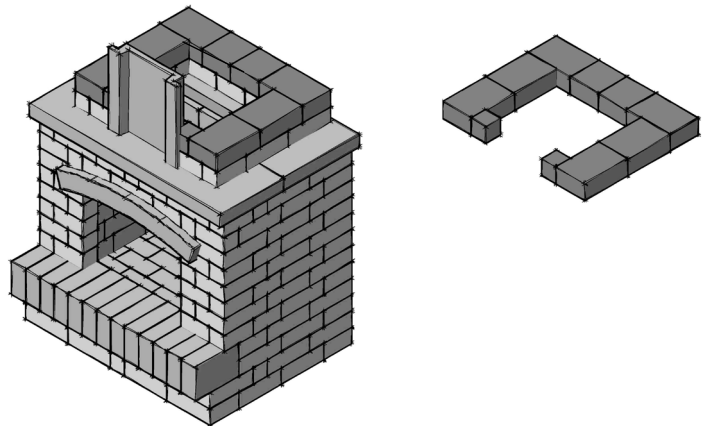

# 21

- A** Repeat steps 19 and 20 to a height of five layers above the mantle, checking that the layers remain level.
- B** Glue the fifth layer down using the included landscape glue.

**USE:**

- (14) 8 x 12 blocks
- (8) 8 x 8 blocks
- (8) 4 x 8 blocks
- (6) 4 x 4 blocks

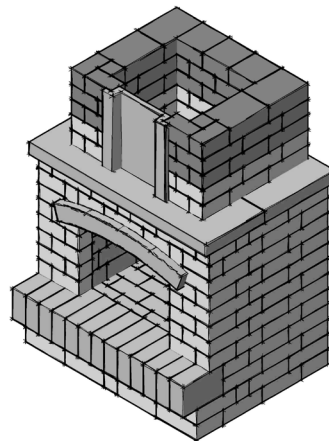

**IMPORTANT:** Allow glue to set for at least 2 hours before installing the roof. Check to ensure the glue has begun to set so that the roof does not move any blocks underneath. Blocks should be steady when moved.

# 22

- A** Place the spark arrestor at the top of the fireplace setup as shown.
- B** Carefully place both front and back pieces of the roof on the wall surround, ensuring that the opening for the chimney is facing the front and aligned with the opening below it.

**IMPORTANT:** The roof is 187 lbs (85 kgs) per piece. Use 2 x 4 inch studs spanning the roof widthwise to lift it. Lower the roof down with the 2 x 4 inch studs, align roof, and then move the wood studs out one at a time while ensuring that the spark arrestor stays in place.

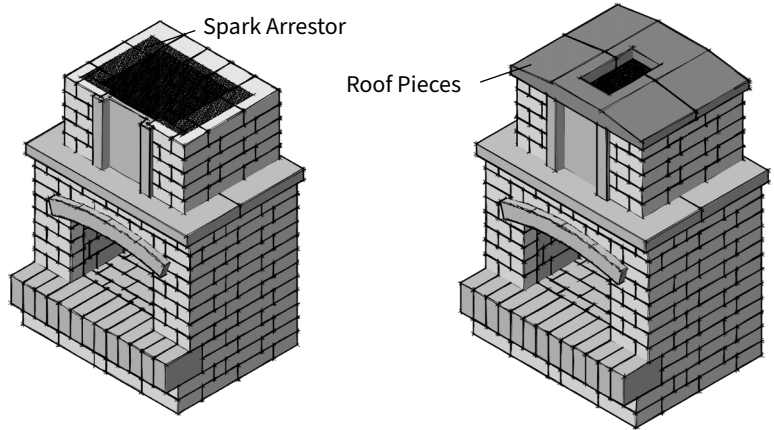

# 23

- A** Lay out the first layer of the chimney as shown in the diagram.
- B** Glue this layer down to the roof using the landscape glue provided.

**USE:**  
(8) 4 x 8 blocks

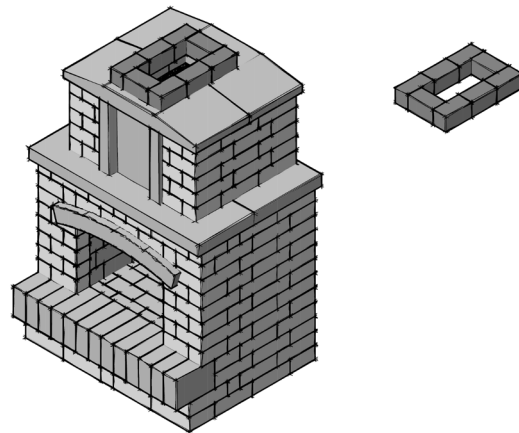

# 24

- A** Lay out the second layer of the chimney as shown in the diagram.

**USE:**  
(8) 4 x 8 blocks

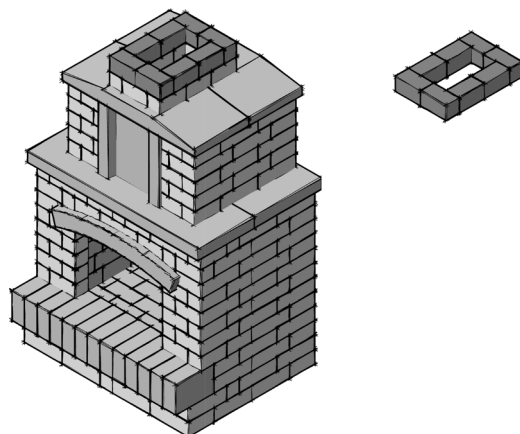

## 25

- A** Repeat steps 23 and 24 to a height of five layers above the roof, checking that the layers remain level.
- B** Glue the fifth layer down with landscape glue.

**USE:**  
(24) 4 x 8 blocks

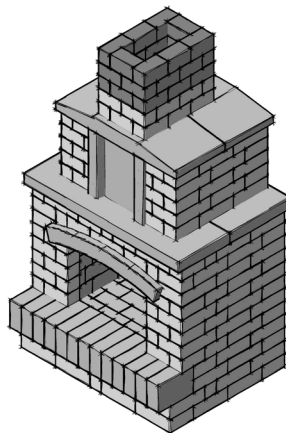

## 26

- A** Install the two-piece Fireplace Cap as indicated in the diagram. Adjust the cap as needed to ensure that it is centred with a 1 3/8" overhang on all sides.
- B** If the rain cap is not going to be installed, glue this layer down with the included landscape glue.

**USE:**  
Fireplace Cap (2 pieces)

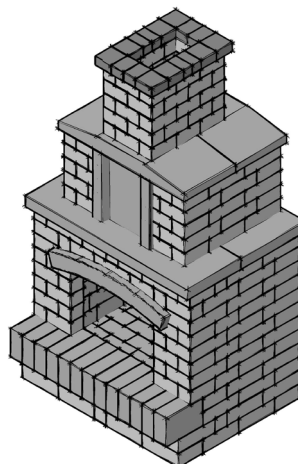

**STOP** Allow 72 hours for glue and silicone to set before first use.

## 27

- A** Lift one side of the fireplace cap and place one side of the rain cap underneath. Lift the other side of the fireplace cap and place the other side of the rain cap underneath.
- B** Glue fireplace cap in place with the included landscape glue.

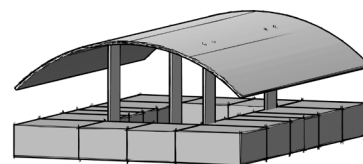
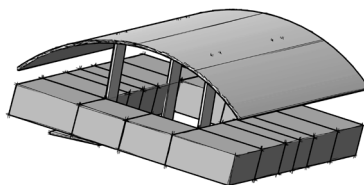

# AFTER INSTALLATION

## CURING INSTRUCTIONS

Upon installation of your new fireplace, there are still small amounts of moisture needing to work their way out of the fireplace. If you immediately begin to build large fires in your fireplace, you will compromise your fireplace longevity and can ultimately cause damage, including cracking. It is then important to build fires slowly to cure the fireplace in preparation for use.

The first day of firing, the temperature should stay close to 100 °C without exceeding it. A suggested way to do so is by building a fire in a separate location, and placing the hot coals into the fireplace floor. Gradually build up from this point to larger and larger fires for 4-5 days.

Due to thermal expansion, surface cracks may appear in the firebox. This is normal, and will not affect the quality of your fireplace.

## OPERATING INSTRUCTIONS

Your fireplace is designed to be used with natural, dry wood products only. **DO NOT USE:** charcoal, pressure treated lumber, chipped wood products, sappy wood (such as pine), laminated wood, or any material other than medium or hard natural firewood. Using wood that is not dry will cause the fireplace to emit a considerable amount of smoke and could also cause permanent damage.

**⚠ WARNING: DO NOT ADD ANY ACCELERANTS OR OTHER NON-WOOD PRODUCTS FOR FIRING**, as this can compromise the integrity of the fireplace firebox, leading to risk of product failure and personal injury. Make sure to avoid extreme heat when in use to prolong the life of your fireplace.

**DO NOT USE LIQUID FUEL** (firelighter fluid, gasoline, kerosene or similar liquids) to start or maintain a fire. Do not use water to lower the temperature or extinguish fire in a fireplace.

Size of fire should never be bigger than the back of the firebox.

**DO NOT BUILD THE FIRE SO THAT FLAMES EXIT THE FIREBOX OPENING.** See illustration below.

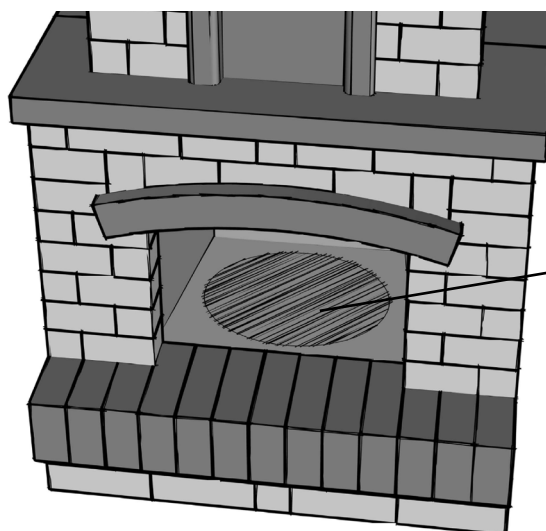

Fire should be limited to within the firebox, as the shaded circle shows.

## **MAINTENANCE INSTRUCTIONS**

1. Make sure that your fireplace is completely cool before inspecting and cleaning it. If fire previously made was a large one, probe through the ashes with a poker or fireplace shovel. Slowly shovel the ashes into a metal container with a tight-fitting lid. This container should be stored on a non-combustible surface, away from fire hazards. Ensure ashes are completely cold before disposing of them appropriately.
2. Use a wire brush to clean the firebox floor.
3. If you have doubts on your ability to clean the fireplace, have it cleaned by a professional. If you were to clean it yourself, make sure to use a brush to clean the inside and outside of your fireplace.
4. If smoke marks begin to appear on the exterior of the fireplace, apply the silicone provided from the interior of the fireplace to fill in any gaps between the Quarry Stones.

# barkman™

## STEINBACH OFFICE

152 Brandt Street,  
Steinbach, MB R5G 0R2  
T 204 326 3445 or 1 800 461 2278  
F 204 326 5915  
Steinbach@BarkmanConcrete.com

## WINNIPEG OFFICE

901 Gateway Road,  
Winnipeg, MB R2K 3L1  
T 204 667 3310 or 1 800 342 2879  
F 204 663 4854  
Winnipeg@BarkmanConcrete.com

## CALGARY OFFICE

813 McCool Street, Box 1136,  
Crossfield, AB T0M 0S0  
T 403 946 4630 F 403 946 4631  
Calgary@BarkmanConcrete.com

## VANCOUVER OFFICE

2104-290 Newport Drive,  
Port Moody, BC V3H 5N2  
T 778 689 7670 or 1 800 461 2278  
F 604 949 0321  
Vancouver@BarkmanConcrete.com

## SASKATOON DISTRIBUTION CENTER

3550 Idylwyld Drive North,  
Saskatoon, SK S7L 6G3  
T 1 800 342 2879

## KELOWNA DISTRIBUTION CENTER

1904 Old Okanagan Highway,  
Westbank, BC V4T 1T8  
T 1 204 346 9490

## SURREY DISTRIBUTION CENTER

8157 132nd Street,  
Surrey, BC V3W 4N5  
T 1 204 346 9490

## BARKMAN CONCRETE LIMITED

[BarkmanConcrete.com](http://BarkmanConcrete.com)

